

**Packaging Information**

• **Tearing Off Force**

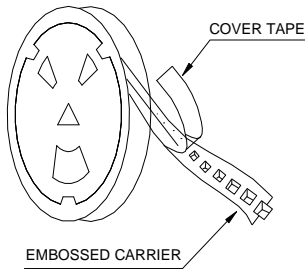

★The force for tearing off cover tape is 10 to 120 grams in the arrow direction under the following conditions.

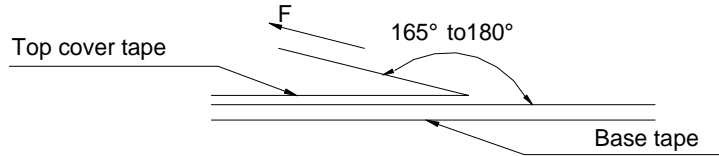

• **DIMENSIONS & RECOMMENDED PATTERN**

TYPE	DIMENSIONS / SIZE (mm)				PATTERN / SIZE (mm)		
	A	B	C	D	E	F	G
<b>JTP 1005</b>	10 ± 0.4	9.0 ± 0.4	5.4 ± 0.40	10 ± 0.4	3.75	2.5	9.5

• **TAPE DIMENSION & REEL DIMENSION**

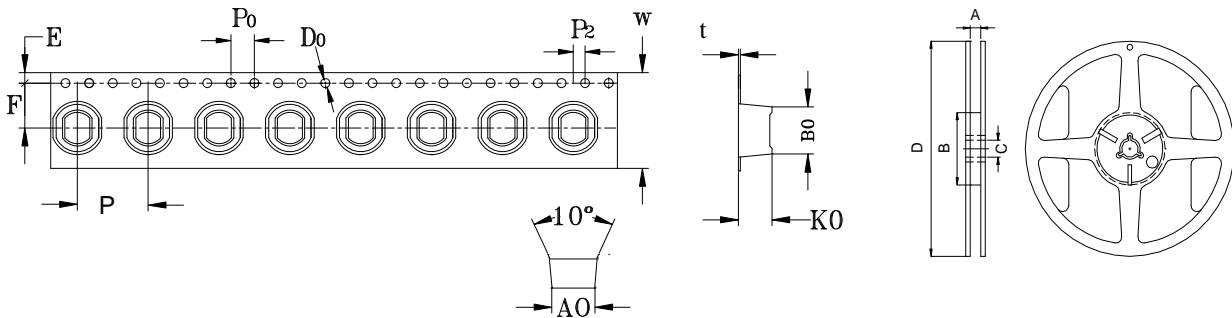

REEL DIMENSION

TYPE	TAPE / SIZE (mm)										REEL 13"×24mm			
	Ao	Bo	Ko	F	E	W	P	Po	P2	t	A	B	C	D
<b>1005</b>	9.3 ± 0.1	10.3 ± 0.1	5.8 ± 0.1	11.5 ± 0.1	1.75 ± 0.1	24 ± 0.3	12 ± 0.1	4 ± 0.1	2 ± 0.1	0.4 ± 0.05	24.5 ± 0.2	100 ± 0.5	13.2 ± 0.3	330 ± 1.0

• **PACKAGING QUANTITY**

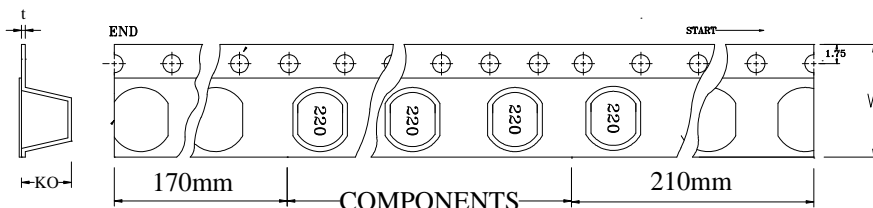

USER DIRECTION OF FEED

<b>Type</b>	<b>JTP 1005</b>
<b>Q'TY/Reel</b>	<b>500</b>